

■ ABM-50 | AUTO-FEED DOUBLE-SIDED BEVELLER

ABM-50 produces accurate high-quality double-sided bevels without thermal distortion or creation of heat affected zone on plate thickness range 8-80 mm (15/16" - 3 1/8") using a purpose designed milling head with eight 4-sided indexable cutting inserts.

Continuously adjustable bevel angle between 15 and 60 degrees (for both top and bottom beveling) requires no tooling to change.



**BREAKTHROUGH
IN BEVELING!**

■ The operator can easily adjust and monitor the following parameters:

- bevel angle
- bevel width
- bevel height
- depth of cut
- spindle speed
- feed rate
- spindle load

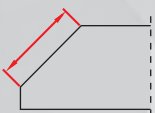

Bevel width
up to 50 mm (2") / 45°
up to 66 mm (2 5/8") / 15°



Bevel angles
top 15° - 60°
bottom 15° - 60°

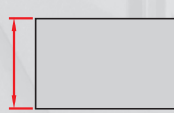

Min plate thickness 8 mm 5/16"
Max plate thickness 80 mm 3 1/8"



Top beveling



Bottom
beveling

■ Features & benefits

- auto-feed portable beveling
- real-time measurement and on-screen display of exact bevel geometry and cutting parameters
- bevel width up to 50 mm (2") at 45 degrees
- 180° inversion allows for creation of a double-sided bevel – no need to rotate or flip heavy material reduces material handling costs and improves shop safety
- variable spindle speed for work on a variety of steel grades and thicknesses
- versatile and transportable on its own trolley
- equipped with milling head including 8 replaceable inserts
- feedback-controlled overload system

■ The ABM-50 features an unique remote control panel with LCD display that shows exact bevel geometry as well as enables precise adjustment of spindle speed and feed speed to optimize them depending on material grade incl. stainless steel, aluminum etc.

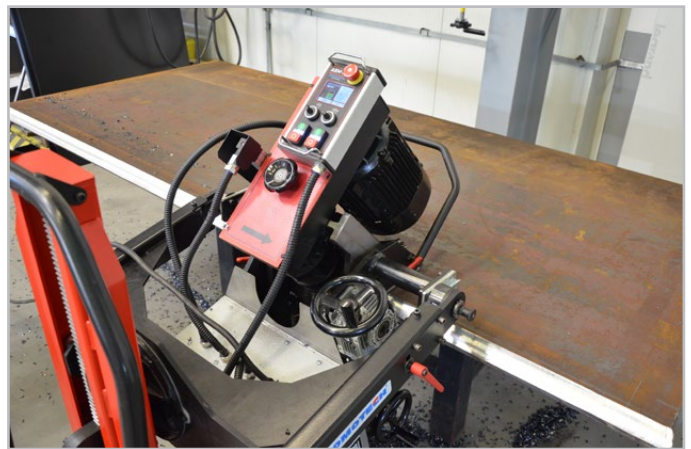

■ ABM-50 can perform beveling along steel plate's edge eliminating hard physical work of the operator. The maximum bevel at 45 degrees is up to 50 mm (2").

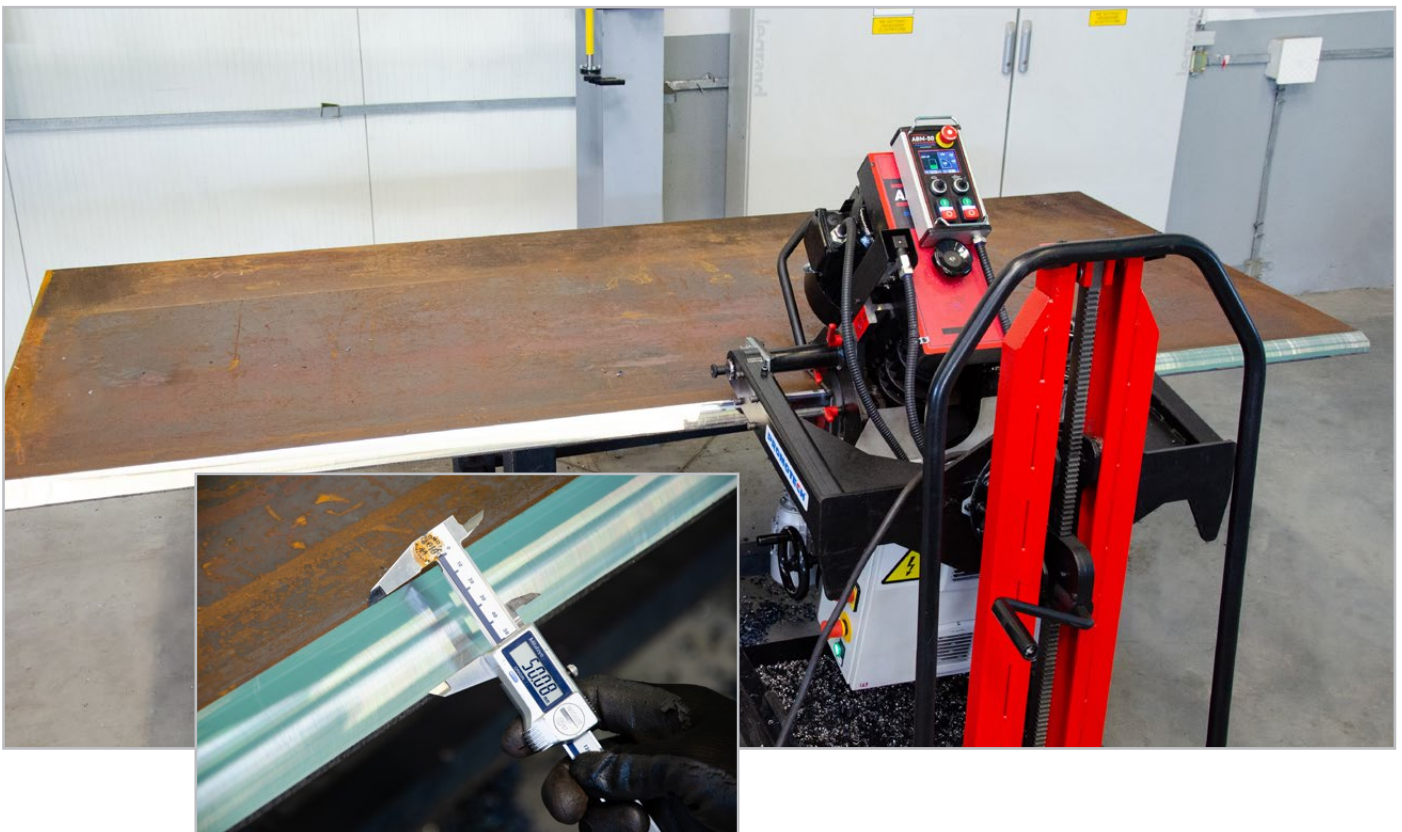

■ ABM-50 can create a double-sided bevel eliminating the need to turn a plate over.



■ Precise adjustment of spindle speed and feed rate to optimize cutting conditions depending on sort of material grade incl. stainless steel, duplex, alloys and aluminum.

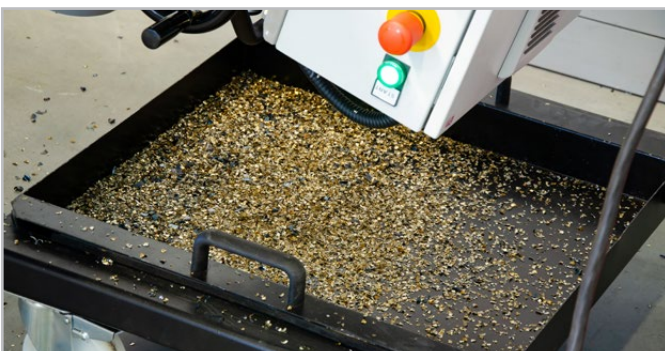

- 180° inversion of ABM-50 enables bottom beveling.
No the need to rotate or flip heavy material that reduces workpiece handling costs and improves shop safety.



Accessories



Milling head
(8 cutting inserts required)
Product code: GLW-000033



Cutting insert 1 piece (sold 10 pcs/box)
Product code: PLY-000282

Cutting insert HD 1 piece (sold 10 pcs/box)
Product code: PLY-000591

- PDK-000268 Shim
- SRB-000466 Shim screw
- SRB-000465 Insert screw for cutting insert

ABM-50 TECHNICAL SPECIFICATION	
Voltage	3- 400 V + PE, 50/60 Hz 3- 480 V + PE, 50/60 Hz
Power	6.5 kW
Spindle speed (no load)	300-800 rpm
Feed speed	0-1.2 m/min (47"/min)
Bevel angle (β , Fig. 1)	15-60°
Maximum bevel width (b, Fig. 1)	50 mm (2")
Maximum depth of cut (d, Fig. 1) allowed per single pass	6 mm (1/4")
Plate thickness	8-80 mm (5/16"-3 1/8")
Required ambient temperature	0-40 °C (34-104°F)
Weight	320 kg (700 lbs)
Product Code:	UKS-0627-10-40-00-0

β	b
15°	66 mm (2 5/8")
30°	52 mm (2")
45°	50 mm (2")
60°	51 mm (2")

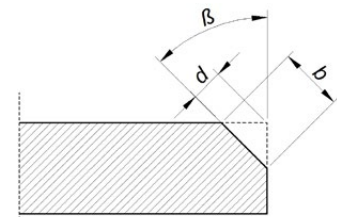
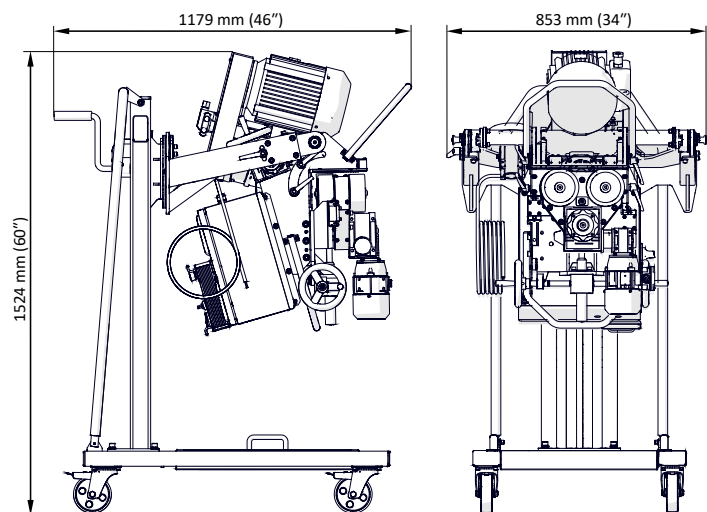

Fig. 1

Standard shipping set:

- Beveling machine with milling head and 8 cutting inserts
- Wooden box with base and mounting brackets
- Special wrench
- 10 mm T-handle hex wrench with ball tip
- 3,5 mm hex wrench
- T15 torx screwdriver
- Grease for screws
- Operator's manual



More information available at www.promotech.eu



PROMOTECH Sp. z o.o.
ul. Elewatorska 23/1, 15-620 BIAŁYSTOK, POLAND
tel. (+48 85) 678 34 05, fax (+48 85) 662 78 77
marketing@promotech.eu www.promotech.eu

Your local dealer:

